

Barrière publicitaire

Cette barrière personnalisable offre une très bonne stabilité grâce à ses pieds bien ouverts. La housse recouvre la structure en aluminium. L'ensemble s'installe en 2 minutes et se range facilement dans le sac de transport fourni.

Advertising barrier

This customisable barrier offers excellent stability thanks to its wide-open feet. The cover covers the aluminium structure. It takes just 2 minutes to set up and is easy to store in the carry bag supplied.

Produit Product



Contenu du kit : Contents :

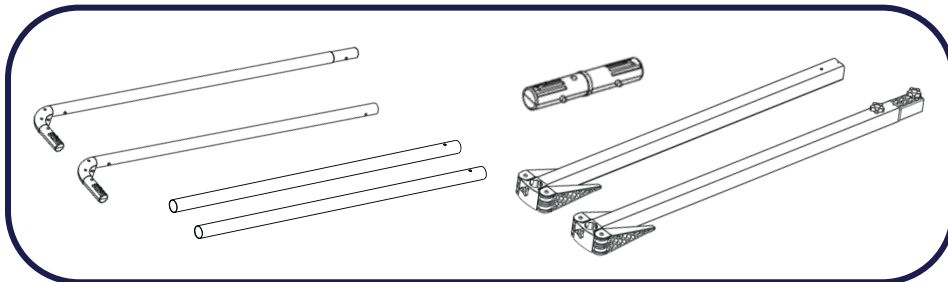

Besoin de plus d'informations ?

Need more information?



Retrouvez notre vidéo Youtube explicative.

Watch our Youtube video.

Contenu de cette notice :

Contents of this manual :

Visuel Printed visual



Structure

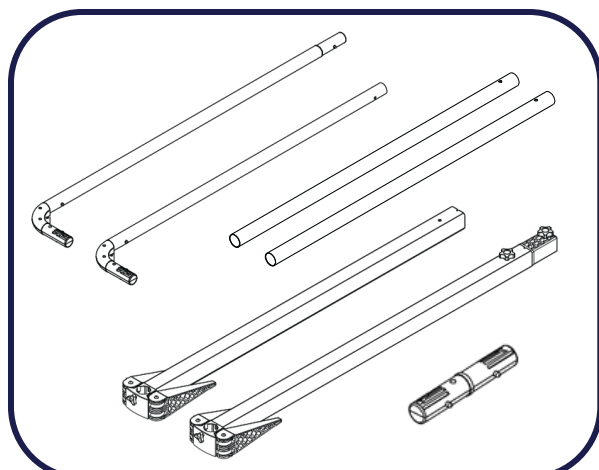

Instruction de montage

Installation instructions

1

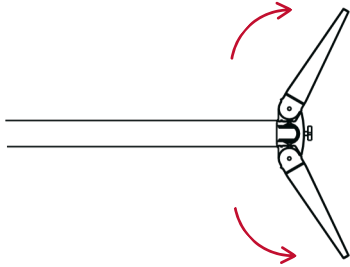

Écarter les pieds pliables.
Spread the folding legs.

2

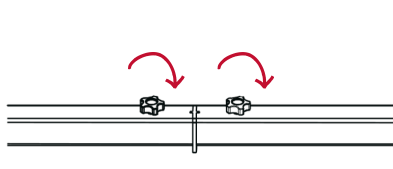

Visser les molettes fermement pour connecter les bases.

Screw the knobs firmly to connect the bases.

3

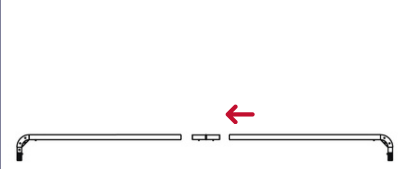

Insérer les éléments dans chaque parties du connecteur.

Insert the components into each part of the connector.

4



Insérer les tiges dans les trous de la base.

Insert the rods into the holes in the base.

5

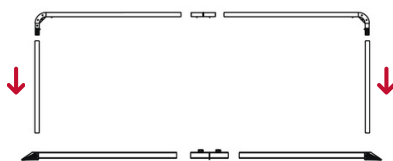

Insérer les tiges dans les trous de la base à nouveau.

Insert the rods into the holes in the base again.

6

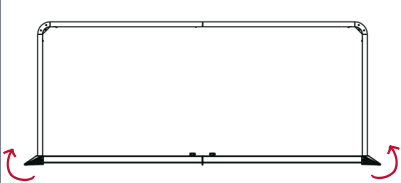

Visser fermement les pieds pour fixer les tiges.

Screw the feet firmly to secure the rods.

7



Glisser le visuel sur la structure.

Slide the visual onto the structure.

8



Voici le produit une fois le montage terminé.

This is the finished product.