

## COMPTOIR D'ACCUEIL

Comptoir d'accueil avec deux plateaux mélaminés en haut et en bas. Structure en cannelure PVC. Visuel en PVC encapsulé fixé sur la structure par deux bandes Velcro. 2 sacs de transports inclus. En option : étagère centrale.

## RECEPTION DESK

Reception counter with two melamine top and bottom panels. Fluted PVC structure. Encapsulated PVC visual fixed to the structure with two Velcro strips. 2 carry bags included. Optional: central shelf.

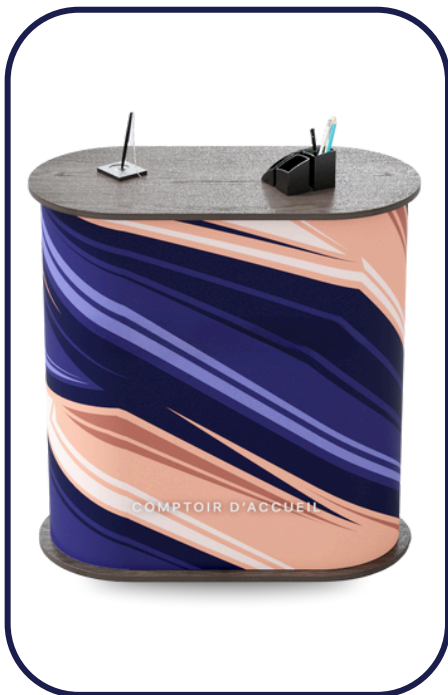

### Contenu des pièces : Contents :

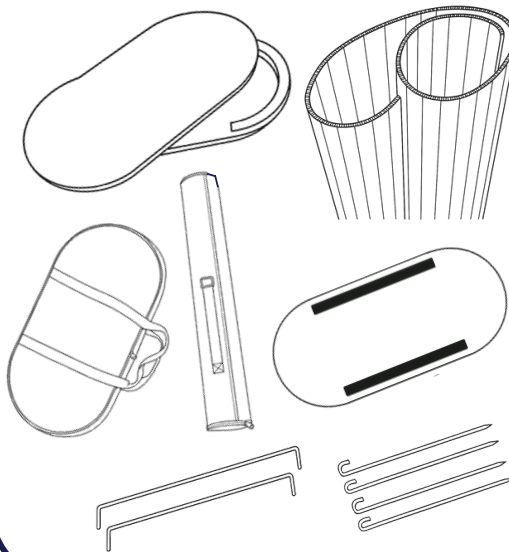

### Besoin de plus d'informations ?

Need more information?



Retrouvez notre vidéo  
Youtube explicative.

Watch our Youtube video.

## Contenu de cette notice :

Contents of this manual :

### Structure

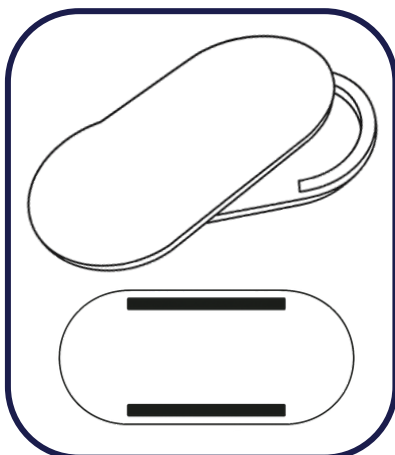

### Visuel imprimé Printed visual

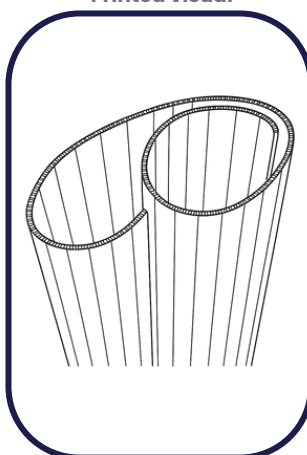

### Sac de transport Carrying bag

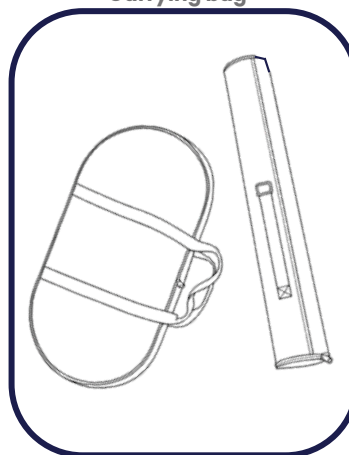

### Sardines

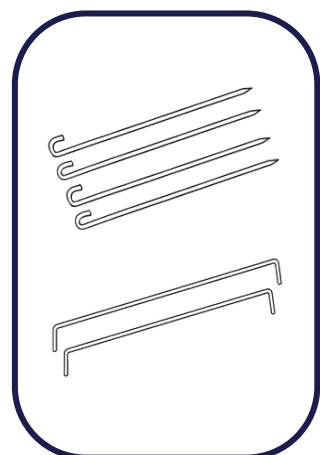

# Instruction de montage

## Installation instructions

1

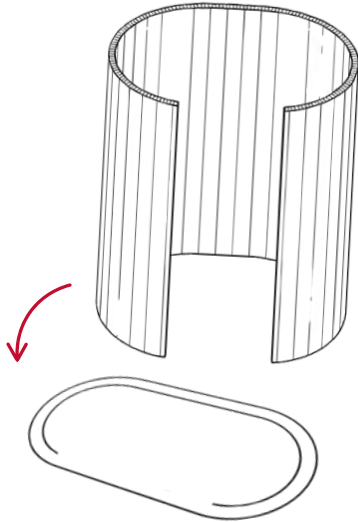

**Déplier la structure et enrouler là autour de l'embase.**

Unfold the structure on each side by pulling on the ends.

2

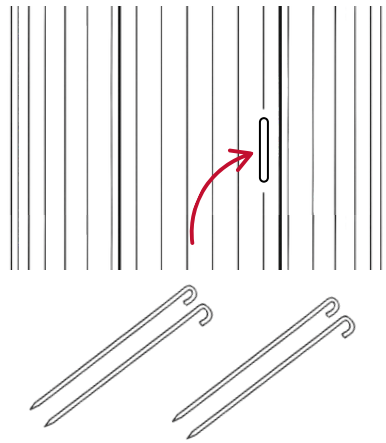

**Placer les sardines dans les 4 encoches à chaque extrémité, de votre visuel.**

Your structure should look like this.

3

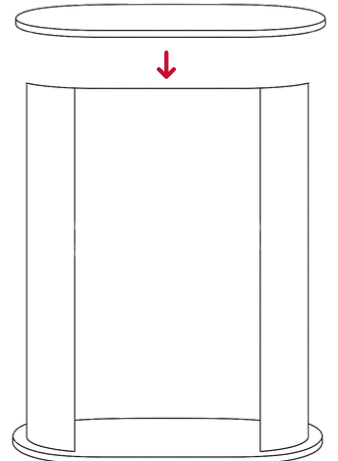

**Déplier légèrement votre visuel afin d'ajouter le plateau sur la partie haute.**

Clip the black clips onto each corner.

4

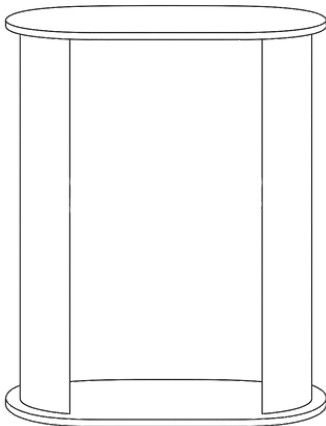

**Voilà le résultat de la structure, vue de l'arrière.**

Secure the structure by inserting the crossbar over the screw.

5

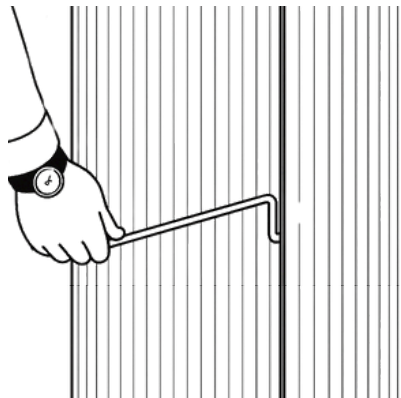

**Insérer le jeu de sardines à chaque extrémités afin de relier chaque côté entre eux.**

Attach your visual to the structure's Velcro fastener.

6

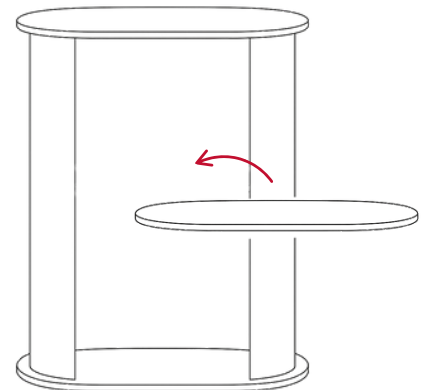

**Ajouter votre étagère sur les sardines.**

Position your board on top of the structure, using the Velcro fastener.